







- 1 ⇒ Monday
 - 2 ⇒ Tuesday
 - 3 ⇒ Wednesday
 - 4 ⇒ Thursday
 - 5 ⇒ Friday
 - 6 ⇒ Saturday
 - 7 ⇒ Sunday
 -  ⇒ Channel ON
 -  ⇒ Channel OFF
- In mode AUTO manual switching possible by pressing relevant keys.

Programming

Key functions

- Menu** Selection of programming modes
AUTO → PR → ? →  → SW → AUTO ...
- [CL]** Clear programmed switch commands in modes PR; ? and .
- [◆]** In PR; ?;  and S/W modes: Select function option of flashing digit resp. position.
In Mode ? : Change selected inputs.
- [O.K.]** Confirm the selected mode.
In PR and  modes: Advance to required position. (forwards)
In ? mode: Advance to next switching time.
In S/W mode: Enter into memory.
- [◀]** In PR and  modes: Return to required position. (backwards)
In ? mode: Return to previous switching time.
- [A]** In AUTO mode:
- [B]** Press for manual override ON or OFF in relevant channel. Holding down key for 3 seconds will switch ON or OFF PERM override. perm will be displayed. Programmed switching functions of relevant channel are suppressed. Cancel permanent ON or OFF by holding down key for a further 3 seconds, perm will disappear.

Programming advice

The default setting on delivery is programmed real time and date, the summertime change is activated.

Battery power reserve:

Either without external power, or during a supply interruption, by operating the O.K. button the display comes on and switching commands can be programmed.

Make inputs step by step. The appropriate position in the display is flashing and can be changed by pressing **◆** key. Advance to next position by using **O.K.** key, go backwards by using **◀** key. Inputs are terminated when flashing finishes.

Installation details

Caution: The installation and assembly of electrical equipment must be only carried out only by a skilled person.

Warranty void if housing opened by unauthorised person.

The high density electronic circuit is protected against a wide range of external influences. Incorrect operating may occur if external influences exceed certain limits.

Reset

Pressing recessed button in the middle of **◀** key and **CL** key, will clear date, real time and microprocessor. Switching programmes normally will not be affected. (Check by Read - Out; "? mode)

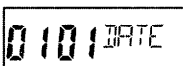

AUTO PR ?  S/W

The  mode is selected because date and real time must be programme new.

Operating modes

- AUTO** Display of time, day of week, current switch status of channel(s). Bar graph display of ON time. Display the current sunset-time (ON) by operating the **O.K.** key and the sunrise-time (OFF) by operating the **O.K.** key a second time. Manual overriding possible (key A, B)
- PR** **Input of switching commands according to week day(s) and time**
Use arrow **◀** and **O.K.** keys to alter flashing digit. Use diamond **◆** key to increase value. (Confirm last input with **O.K.** key, will enter into memory)
- ?** **Displays number of free memory locations**
Selects the selected Astro-table
Show switching times
After switching time
Clear single or all switching times
Use **O.K.** key forwards or **◀** key backwards to display switching times.
Use diamond **◆** key to change (alter) displayed switching time.
Use **CL** key to cancel the displayed switching time.
Use **CL** key twice to cancel all switching times if number of free memory locations available displayed only.
- Input of actual date and time**
Use arrow **◀** and **O.K.** keys to alter flashing digit.
Use diamond **◆** key to increase value. (Confirm last input with **O.K.** key, will enter into memory and change into AUTO mode)
- S/W** **To activate / deactivate the summer/winter time change over.**
Use diamond **◆** key to select automatic S/W - time change ON or OFF. (Confirm last input with **O.K.** key, will enter into memory and change into AUTO mode)

Astro-function

- The switch function OFF in Astro mode is aligned with sunrise
- The switch function ON in Astro mode is aligned with sunset
- Each switch-time can be programmed alternatively as Astro, or as normal switch-time.
- With the two channel version each channel can be programmed separately to be Astro or normal switching function.
- If the Astro-function is chosen for a switch-time, the sunrise (turning off) as well as sunset (turning on) times programmed for the current day will be shown in the Display -
- this time can be changed as required and becomes automatically modified each successive day in accordance with the chosen Astro table -
- the difference (offset) between the entered switch-time and the sunrise/set-time is fixed for successive operations
- The programmed switching times, (mode Pr), as well as the indicated Astro-switch times (mode?) are always applied exclusively to the current day.
- In mode AUTO The current sunset-time can be read by pressing button **O.K.**, and by pressing **O.K.** twice the current sunrise-time is displayed
- In mode ? the matching astro-table must be chosen as the first step.

Astro table — custom on request

Mode ?

Select time zone. (see astro table)

Prior to programming switching commands it is necessary to select the installation time zone.

A different Astro-table can be chosen at anytime. The currently programmed Astro-switch times are automatically re-calculated after the selection of the new table. Programmed Astro-switch times can be checked, amended or deleted and input again..

Example: Astro-table 05 (At 05) required.
Start from: Mode AUTO;
Astro-table 01 (At 01) active.

Push button  2x, & button **O.K.** 1x

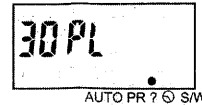

Display of free programming commands

Push button **O.K.** 1x

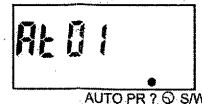

Push button **◆** 1x

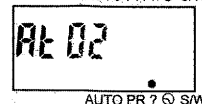

Push button **◆** 3x

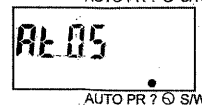

After programming, viewing or amending time zone, by pressing button **O.K.** switching commands can be viewed, programmed or amended.
To return to AUTO mode press  button once.

Mounting advice

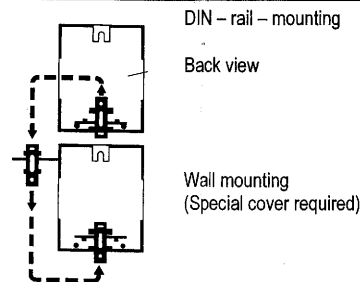

Wiring diagrams

Connect to voltage and frequency according to type label only.

1 channel
SC 28.13
172 413

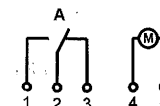

2 channel
SC 28.23
172 423

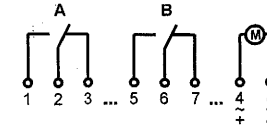

Examples

mode

Current date and real time input or change

Example: Date 01.02.2000; time 14:00 after Reset

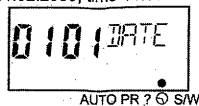

O.K. 3x

◆ 1x

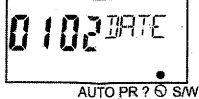

O.K. 2x

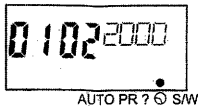

O.K. 1x

◆ 1x

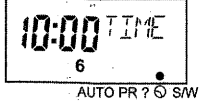

O.K. 1x

◆ 4x

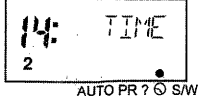

O.K. 3x

Mode PR

Programming day or week program

Is the matching Astro-table already chosen?

Several possibilities:

1. Single day, one channel
2. Several days, one channel.

The switch-times can be programmed as Astro-switch times or as normal switch-times.

Each switch command with Astro-function can be programmed during input with a fixed offset time.

The fixed offset is applicable to **this** switch command on all following days.

Example: Tuesday (2) and Thursday (4) to Sunday (7); Switching time 08:30;

Channel B OFF **with Astro-function and adaptation** respectively different time to sun-switching time.

Start from: AUTO mode

○ 1x

O.K. 1x

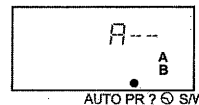

O.K. 1x

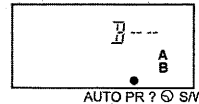

◆ 1x

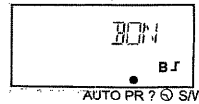

◆ 1x

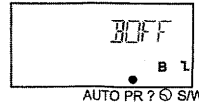

O.K. 1x

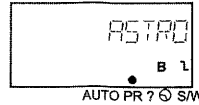

The next example is a program that can differ from the chosen Astro-table by a programmed time offset.

O.K. 1x

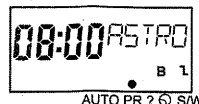

O.K. 2x

◆ 3x

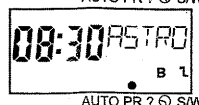

O.K. 2x

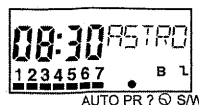

Red: Flashing symbol in display

◆ 1x

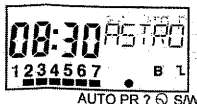

O.K. 2x



◆ 1x

O.K. 4x

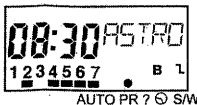

O.K. 1x

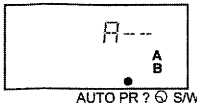

Continue with input of further dates / functions or press key ○ 1x to return to mode AUTO

Example: Tuesday (2) to Sunday (7); Switching time 10:00;

Channel A ON **without Astro-function**

Start from: AUTO mode

○ 1x

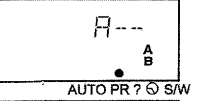

◆ 1x

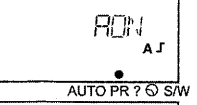

O.K. 1x

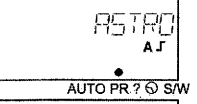

◆ 1x

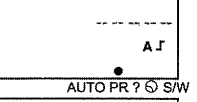

O.K. 1x

◆ 1x

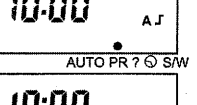

O.K. 4x

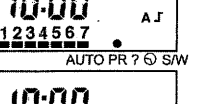

◆ 1x

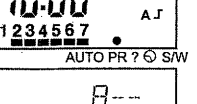

O.K. 7x

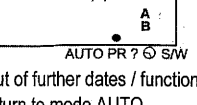

Continue with input of further dates / functions or press key ○ 1x to return to mode AUTO.

S/W mode (daylight saving)

Deactivate automatic summertime changes

The default setting on delivery, S/W time change is activated.

Initial form: AUTO mode

○ 4x

O.K. 1x

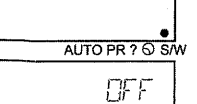

◆ 1x

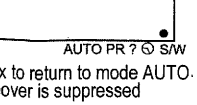

Press key ○ 1x to return to mode AUTO.

The S/W - changeover is suppressed

At summertime-changeover, the Astro-switch times are also converted to the new time.

The time changeover is executed automatically according to the „European Regulation“.

Start: Last Sunday in March

End: Last Sunday in October

? mode

Display or alter switching times

Example: Alter Tuesday and Thursday to Sunday 08:30; Channel B OFF

into: Wednesday to Sunday 08:15; Channel B OFF with Astro-function

Start from: AUTO mode

○ 2x

O.K. 1x



O.K. 1x

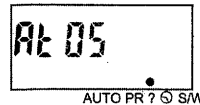

O.K. 1x



O.K. 1x

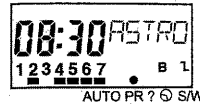

◆ 1x



O.K. 1x

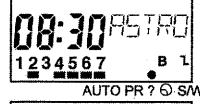

O.K. 3x



◆ 4x

O.K. 1x

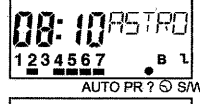

◆ 5x

O.K. 2x

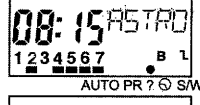

◆ 1x

O.K. 1x

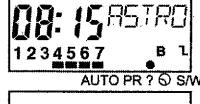

◆ 1x

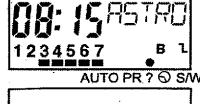

O.K. 5x

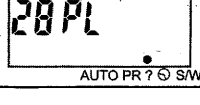

? mode

Cancel function

Example: Tuesday (2) to Sunday (7); Switching time 10:00; Channel A ON without astro-function

Start from: AUTO mode

○ 2x

O.K. 1x

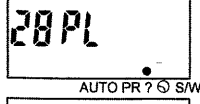

O.K. 2x

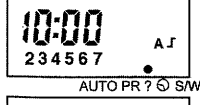

CL 1x

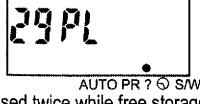

If CL key is pressed twice while free storage locations available are displayed, all inputs are cancelled. (Clear all)